

Work happily



V1.2

naggura'swop

naggura.com

Unsere Produkte



Swop S3 HT SPA ist eine dreiteilige elektrische Liege mit einer einteiligen Matratze, Verkleidung aus Holz, TwinLift Armstützen und Polsterheizung.

Holz, Metall oder PMMA



Kollektionen

Nordic
METALL

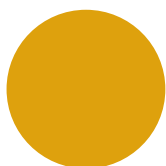

Yellow

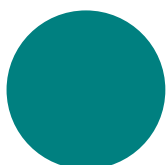

Blue

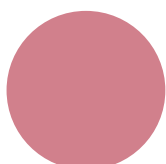

Pink

Foll
METALL



Ash

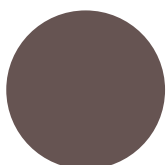

Clay

Iron
METALL

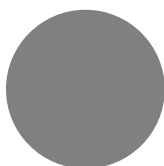

Inox

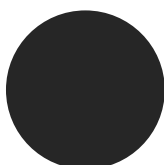

Black

Om
HOLZ



Oak



Wenge

Techno
PMMA



Fluor

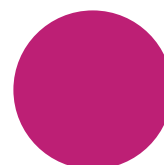

Fuxia



Ice

SWOP S3 HT SPA



Abmessungen

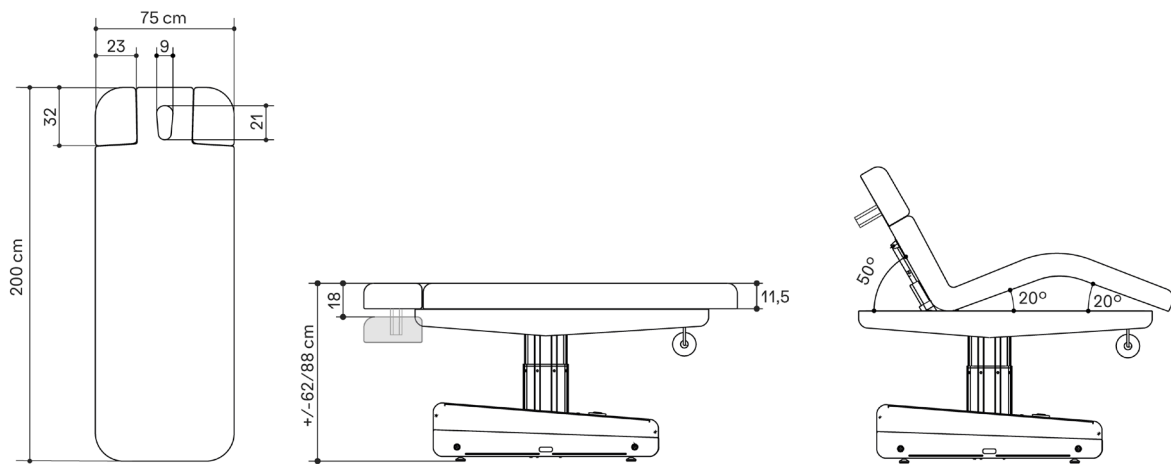

Technische Angaben

MOTOREN

3 Motoren (Höhe, Rückenlehne und Beinteil)

ABMESSUNGEN (LÄNGE X BREITE)

200 x 75 cm

HÖHE (MIN. UND MAX.)

62/88 cm

GEWICHT

110 kg

POLSTERDICKE

11,5 cm (10 cm Latex und 1,5 cm Sperrholz)

DICHTE

30 kg/m³

BELASTBARKEIT

175 kg

BEDIENUNG

Handfernbedienung (serienmäßige Ausstattung)/
Fußfernbedienung (optional)

STROMVERSORGUNG

230 V - 50/60 Hz

MAX. INTENSITÄT

2 A

ELEKTRISCHER MOTOR

6.000 N

ANGABEN

TwinLift Armstützen
Polsterheizung
Papierrollenhalter

POLSTERUNG

Nahtloser Polsterbezug und mit abgerundeten Kanten.

Naggura Skin Polsterbezug: 100 % Vinyl-Mischung in Weiß.

Abriebfestigkeit: >250.000 Zyklen. Schutz vor Keimen und UV-Strahlen.